



3YM30AE Series

Configuration	4-stroke, vertical, water-cooled diesel engine		
Maximum output at crankshaft	* 21.3 kW@3200 rpm	[29.1 mhp@3200 rpm]	
Displacement	1.266 ltr	[77 cu in]	
Bore x stroke	80 mm x 84 mm	[3.1 in x 3.3 in]	
Cylinders	3		
Combustion system	Indirect injection		
Aspiration	Natural aspiration		
Starting system	Electric starting 12V - 1.4 kW		
Alternator	12V - 125A		
Cooling system	Fresh water cooling with heat exchanger		
Lubrication system	Enclosed, forced lubricating system		
Direction of rotation [crankshaft]	Counterclockwise viewed from flywheel side		
Dry weight without gear	127 kg	[280 lbs]	
Environmental	EU: RCD	BSO II	EMC
	US: EPA Tier3		
Engine mounting	Rubber type flexible mounting		

NOTE:

Fuel condition: Density at 15°C = 0.84 g/cm³; 1 kW = 1.3596 mhp = 1.3410 HP
 * Fuel temperature 40°C at the inlet of the fuel injection pump [ISO 8665:2006]
 Technical data is according to ISO 8665: 2006

DIMENSIONS

Rear view

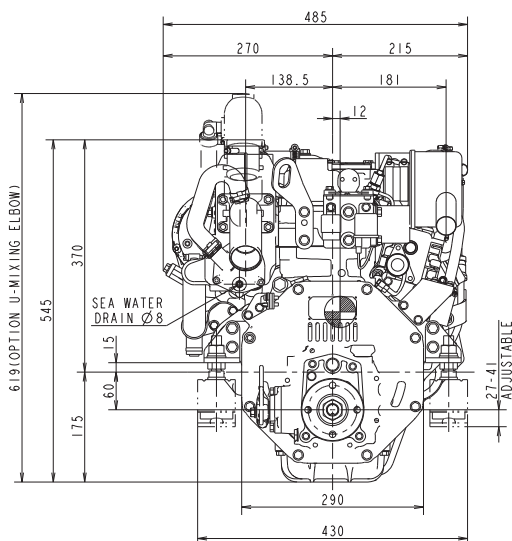

Right side view

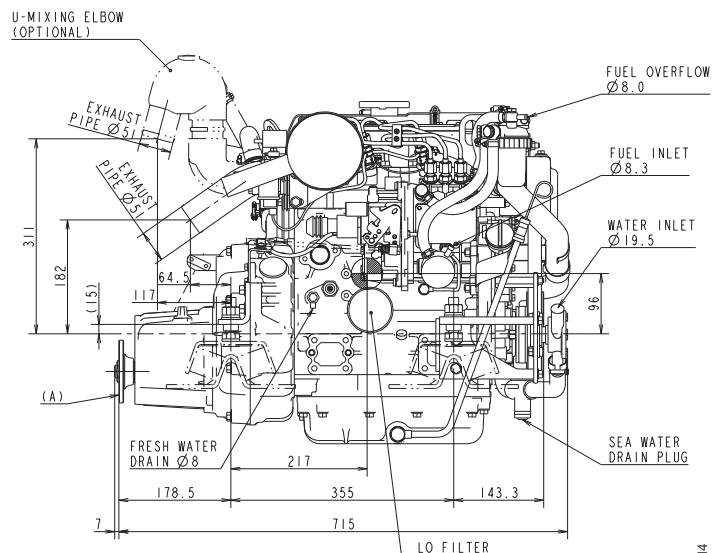

3YM30AE with KM2P-1 marine gear



PERFORMANCE CURVES

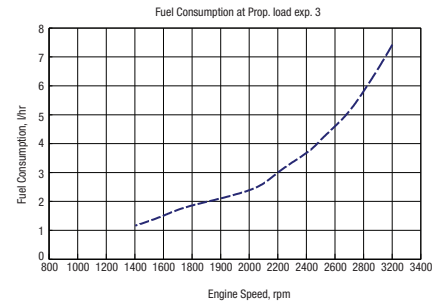
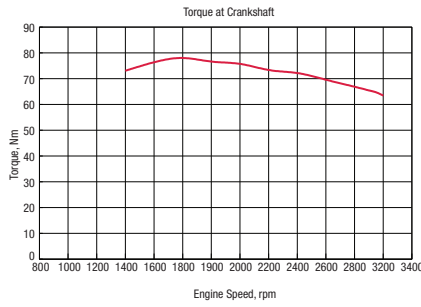
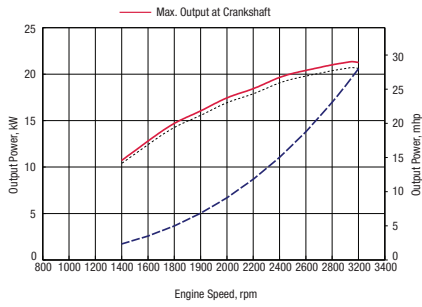

MARINE GEARS / DRIVE

Model	KM2P-1	Saildrive [SD25]
Type	Constant mesh gear with servo-cone clutch	Constant mesh gear with dog clutch
Dry weight	10 kg [22 lbs]	30 kg [66 lbs]
Reduction ratio [fwd/asn]	2.21/3.06	2.64/2.64
Propeller speed [fwd/asn]	1287/930	1085/930
Direction of rotation [propeller shaft - fwd]	Clockwise viewed from flywheel side	Counterclockwise viewed from flywheel side
Dry weight engine and gear/drive	133 kg [293 lbs]	157 kg [346 lbs]
Length engine and gear/drive	715 mm [28 in]	899 mm [35 in]

INSTRUMENT PANELS

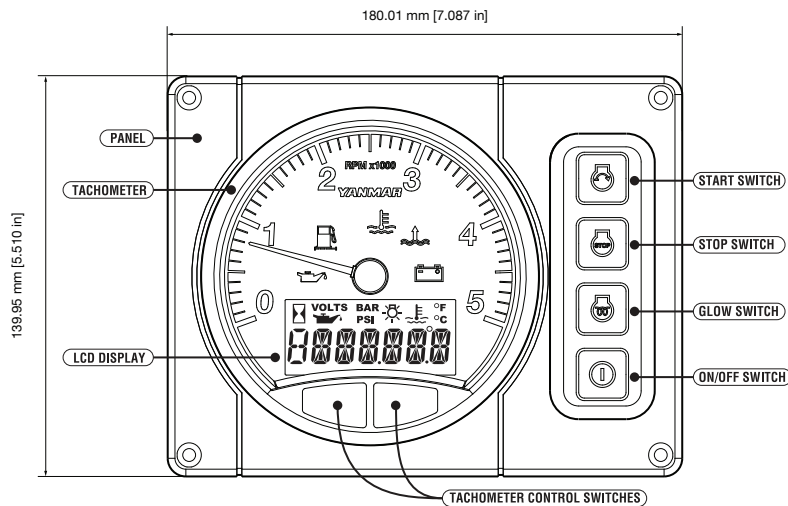

B20 STANDARD

ACCESORIES

Standard engine package

- Set of flexible mounts
- Exhaust mixing elbow [L-type]
- V-belt safety cover
- Expansion tank for fresh water cooling system
- Alternator 12V - 125A
- Electric stop solenoid
- Operation manual
- Sensor for instrument panel
- B20-panel

Optional accessories:

- Extension wire harness [4m, 6m, 10m]
- High riser mixing elbow [instead of L-elbow]
- Hot water kit with cocks
- Second station harness
- Propeller cone nut kit SD25

NOTE: All data subject to change without notice. Text and illustrations are not binding.